

Specification:

- Self-turning range: 20-2000uh
- Voltage: 12-24VDC or 85-240VAC
- Relay output: presence relay/fault relay
- Working temperature: -40°C - +70°C
- Frequency: 4 steps switch, 20-80KHz
- Response time: turn on 10-90MS, turn off 10-90NS
- Reset: reset by push button on front of enclosure
- Humidity: up to 95% relative humidity without consideration
- Sensitivity: 16 ways selectable, highest: 0.010% DL/L, Lowest: 2.56% DL/L
- Loop wire: more than 10 meters requires the use of a 2 core shielded cable, do not exceed 30 meters distance between control box and loop
- Size: 75mm*43mm*110mm

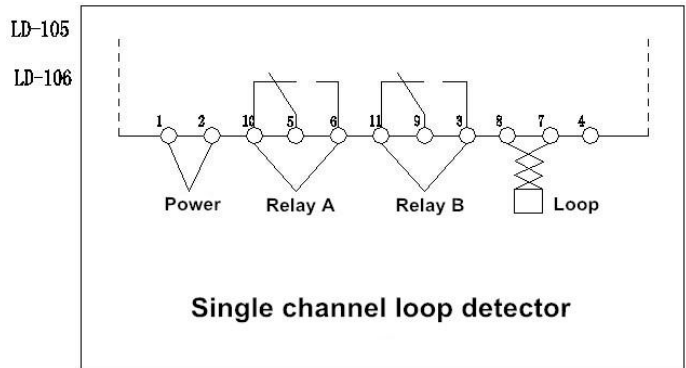

Connections:

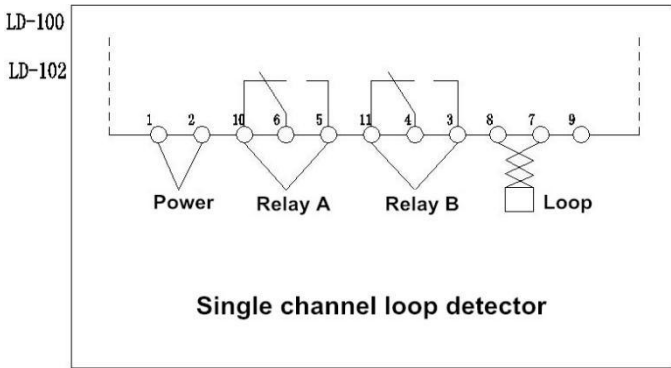

Faceplate LED indication:

- Red-Power
- Green-Loop/Fault
- 1. Undetect - off
- 2. Detect - on steady
- 3. Fault - flashing

Power indicator →

Loop / Fault detect indicator →

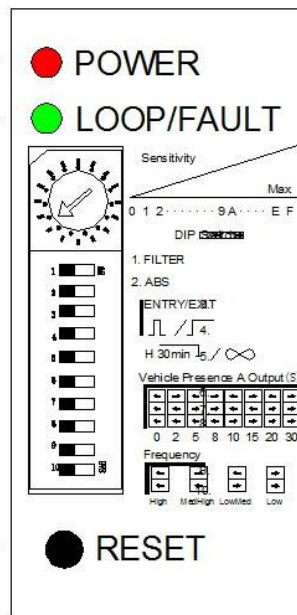

Faceplate setting:

- Sensitivity
- Filter
- ABS
- Entry/Exit
- Presence time
- Delay time
- Frequency

Reset key →

Switch instruction:

Switch 1 (Trimpot), Sensitivity Selection

Sensitivity of the loop can be adjusted by the trimpot labeled "Sensitivity". User can select 16 different setting by turning the trimpot with 0 being the least sensitive and "F" being the most sensitive.

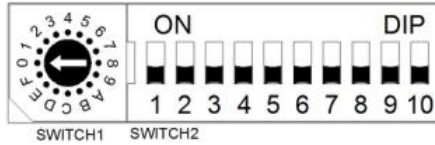

Switch 2 (Dipswitch Settings)

1. DIP 1 & DIP 2 Setting Special Functions

DIP NO.	DIP MODE	Function
DIP 1	ON	Output has 2 seconds delay. (No relay output if the vehicle speed is over 8km/h).
DIP 2	ON	Increase sensitivity to avoid unwilling relay off for leaving vehicle especially for trailer.









2. DIP 3 & DIP 4 Setting Relay B Output

DIP NO.	DIP 3	DIP 4	Relay B Output
DIP MODE	OFF	OFF	When vehicle is moving out, output for relay B is 200m/s.
	ON	OFF	When the vehicle has left, output for relay B is 600m/s.
	OFF	ON	Relay B will be present output. No reaction on Dip switches 3.
	ON	ON	Can be used to test the Loop. If the loop is faulty, Relay B will be on and it will switch off once the fault is fixed.

3. DIP 5 Setting Automatic Reset

DIP NO.	DIP 5	Present Mode
DIP MODE	ON	Vehicle can be permanently present (no auto-reset , unless vehicle has left or manual reset)
	OFF	Normal mode (automatic reset after 30 minutes present of vehicle, used to solve the mistake operation. If it is recommended).

4. DIP 6 & DIP 7 & DIP 8 Setting Relay A Delay

DIP NO.	DIP 6	DIP 7	DIP 8	Delay	A Output 
DIP MODE	OFF	OFF	OFF	0 sec	Output 
	ON	OFF	OFF	2 sec	Output 
	OFF	ON	OFF	5 sec	Output 
	ON	ON	OFF	8 sec	Output 
	OFF	OFF	ON	10 sec	Output 
	ON	OFF	ON	15 sec	Output 
	OFF	ON	ON	20 sec	Output 
	ON	ON	ON	30 sec	Output 

5. DIP 9 & DIP 10 Setting Frequency (40 K to 100 KHz). Used to avoid the interference

DIP NO.	DIP 9	DIP 10	Frequency
DIP MODE	OFF	OFF	High
	ON	OFF	Medium-High
DIP NO.	DIP 9	DIP 10	Frequency
DIP MODE	OFF	ON	Medium-Low
	ON	ON	Low

* In the application, where two or more loop detectors and sensing loops have been installed, set one detector to high frequency and the other set to low frequency to minimize the effects of cross-talk between the two systems(The sensing loops and detectors should be positioned at least 2m apart).

Reset Key: Please note: The LD-100 must be reset every time a setting change is made to the Dip switches.

Detector position and installation:

1. Install the detector in a weatherproof housing.
2. The detector should be as close to the sensing loop as possible.
3. The detector should always be installed away from strong magnetic fields.
4. Avoid running high voltage wires near the loop detectors.
5. Do not install the detector on vibrating objects.
6. When the control box is installed within 10 metres of the loop, normal wires can be used to connect the control box to the loop. More than 10 metres requires the use of a 2 core shielded cable. Do not exceed 30 metres distance between control box and loop.

7. When installation, please keep the product plug and socket in the vertical direction

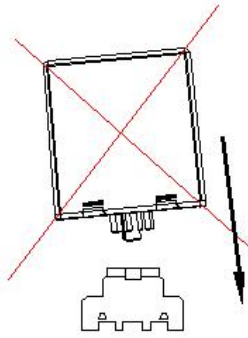

Wrong installation

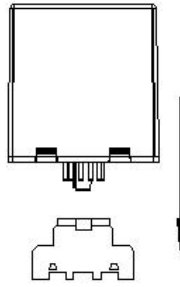

The correct installation

Loop Installation:

The loops are sealed using a “quick-set” black epoxy compound or hot bitumen mastic to blend with the roadway surface.

Loop perimeter	Cylinder numbers
3 ~ 4 M	6
4 ~ 6 M	5
6 ~ 10 M	4
10 ~ 20 M	3
20 M~ UP	2

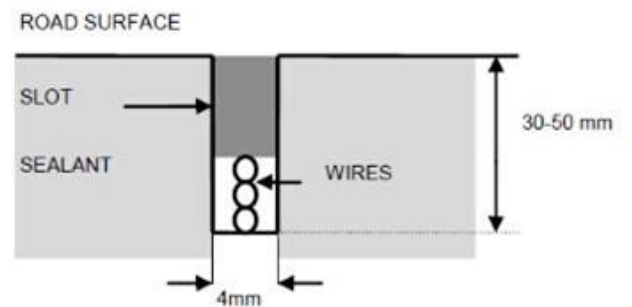
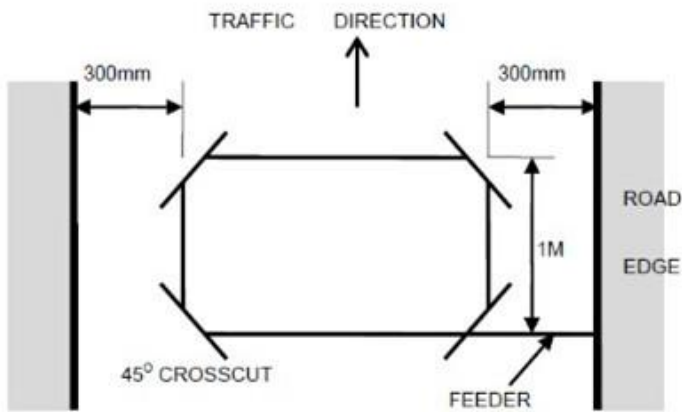

Loop coil details:

Formal national standard loop detector the coil, High temperature wire, High temperatures resistant, There are many colors. (There are some vendor using ordinary tinned wire posing as high-temperature wire sales, the kind of low-cost wire, but the laying of a long-term use of hidden dangers, please buyers attention to distinguish.)

Which are 19 tinned copper wire, different specifications, different brass wire diameter, teflon outer sheath , high temperature waterproof anti-corrosion, dedicated to the loop detector of the coil.(this kind of wire often used in high temperature environment, in order to prevent high temperature oxidation. State regulations and industry specifications using tinned copper wire as a conductor, tinned copper wire outside the silver-white metallic luster, cut open inside is pure copper. **So please buyers don' t have to question whether the fine copper.**

National standards loop detector wire

High
temperature
resistant
anti-aging



Corrosion
resistant
and
acid
alkali



0.75 square
19 bar 0.23 tinned
copper brass wire

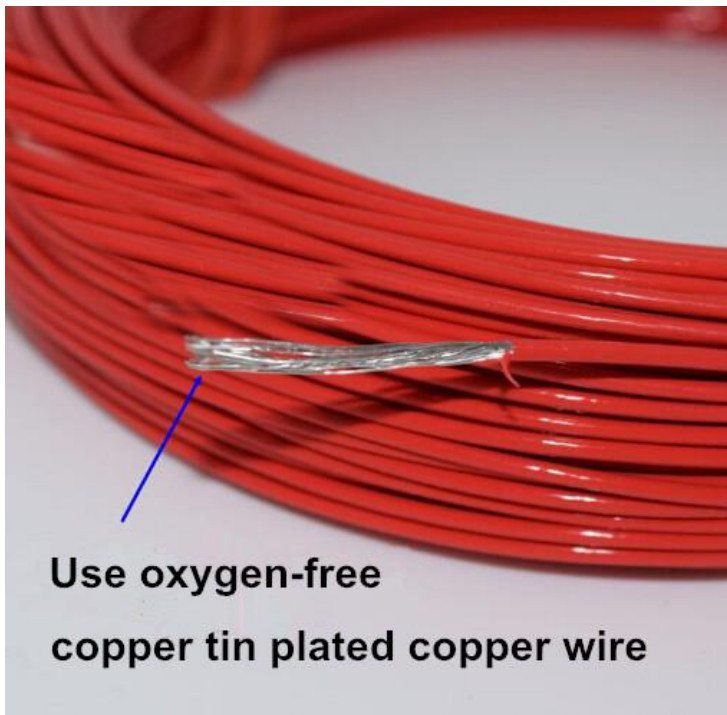

Use oxygen-free
copper tin plated copper wire

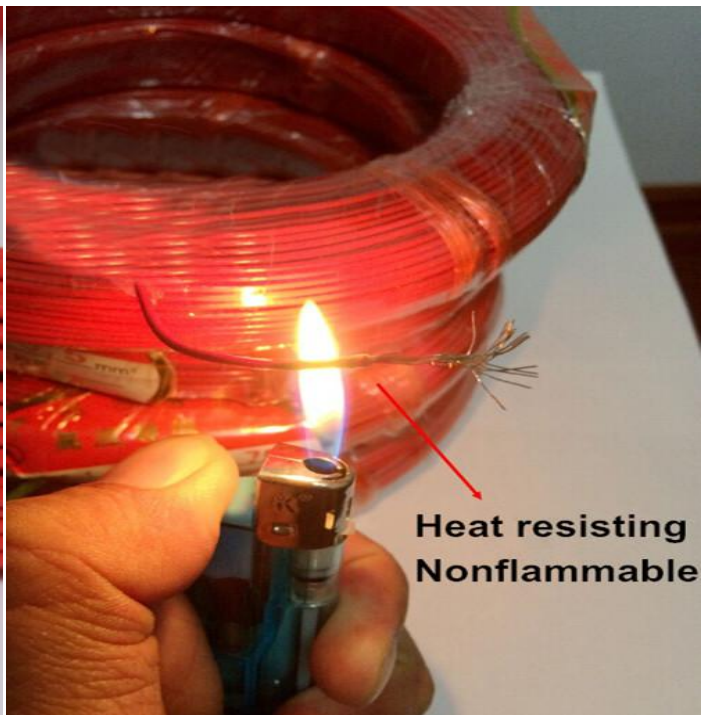

Heat resisting
Nonflammable

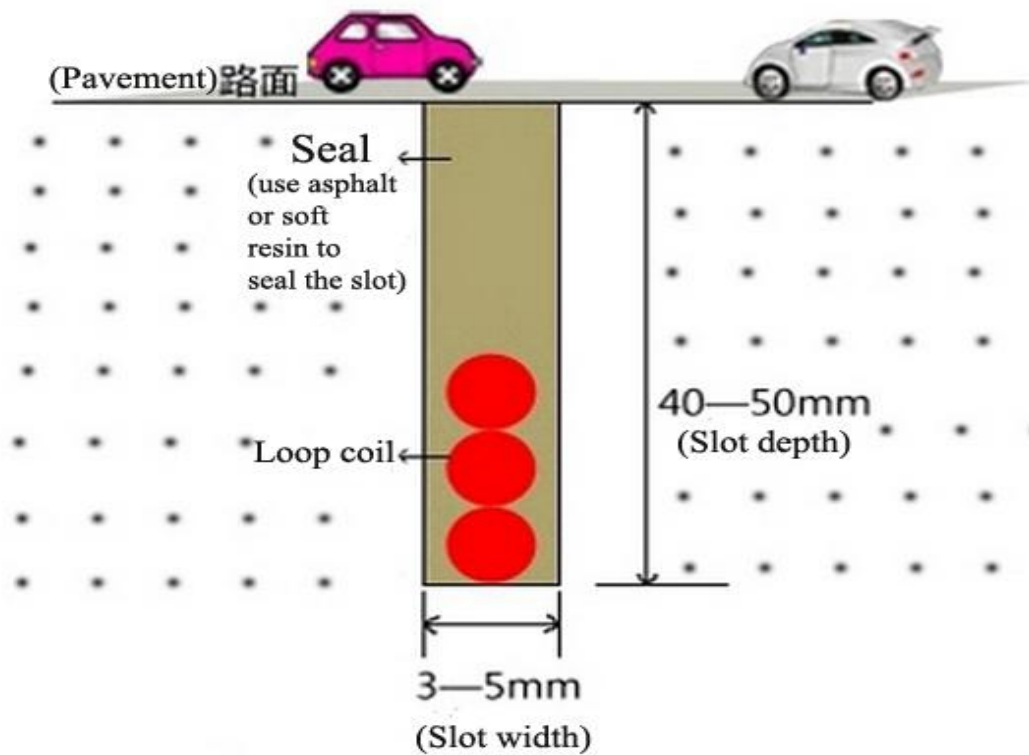

Wire slot cross-section drawn

Installation instructions:

Usually the detection loop should be rectangle. The two long sides are perpendicular to the direction of the movement of the metal object. The gap between them is recommended to be 0.8-1 meter. The length of the long side depends on the width of the road. Generally the both ends are narrower than the separation distance of the road for 0.3-1 meter.

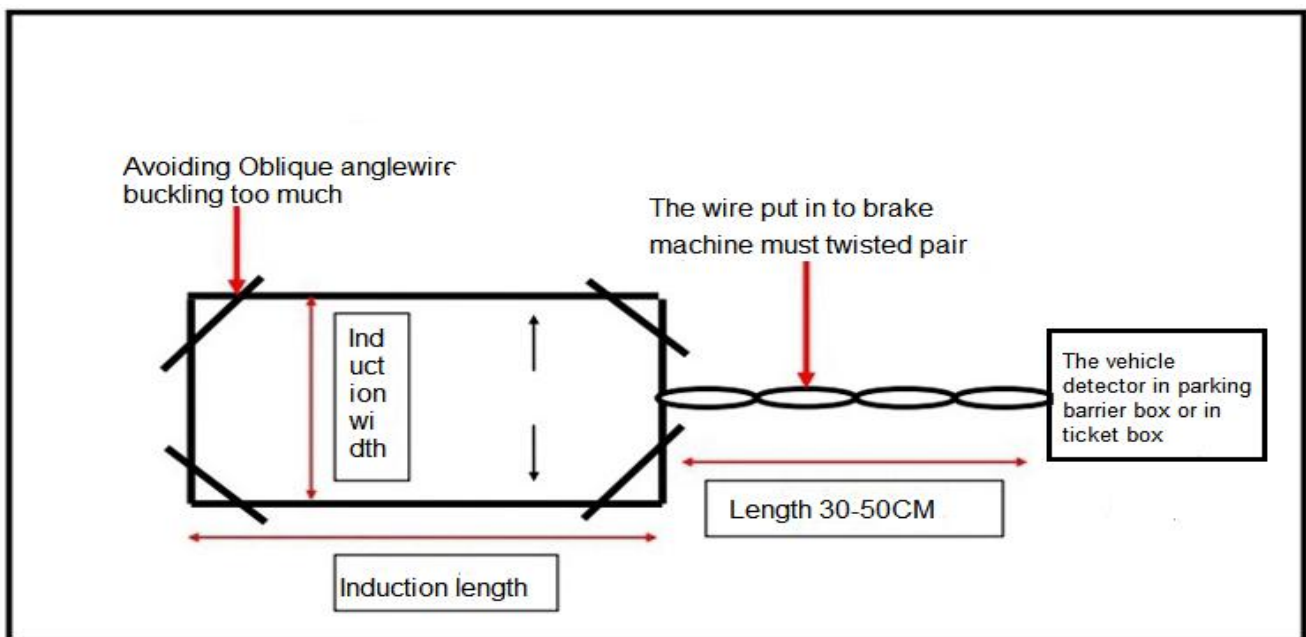

Cylinder numbers:

In order to make the detector work in the best condition, the inductance of the loop coil should be keep between 100uH-300uH, In the case of loop coil inductance unchanged. The cylinder numbers has an important relationship with the perimeter, the perimeter is smaller,cylinder more and more, please refer to the following chart:

Loop perimeter	Cylinder numbers
3 ~ 4 M	6
4 ~ 6 M	5
6 ~ 10 M	4
10 ~ 20 M	3
20 M~ UP	2

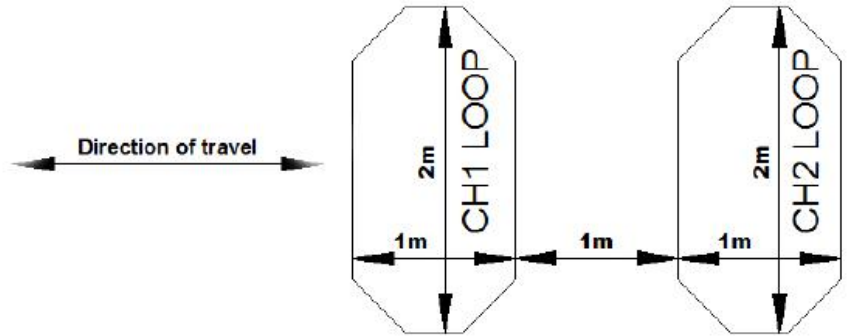

Due to underground road may be buried a variety of cable, pipe reinforcement,sewer cover and other metal substances. These will have a significant effect on the actual loop coil inductance, Therefore, the above table data is just for user reference. In the actual construction, the user should use the inductance test equipment to test the actually inductance value of loop coil to determine the actual Cylinder numbers. As long as make sure the final coil inductance value stay in the reasonable range of work(such as 100uH--300uH).

Bury loop coil method:

First use road cut equipment to cut the slot on the pavement, The four corner angle must be 45 degree. In order to prevent the sharp corner destroy the loop wire, The slot width is generally 4 to 8mm,depth 30-50mm.At the same time need cut a pass slot to the roadside, it need to make sure no water in the slot, The loop wire must be straightened when twisting, also not stretch too tight and close to the slot bottom. After finish twist the loop wire, put twisted output wire through lead-out slot, In the process of twisting loop wire, must use the inductance test equipment to measure the loop wire inductance value, and to ensure the inductance value of the loop coil between100uH-300uH.Otherwise, the Cylinder numbers should be adjusted. After buried the loop coil, in order to strengthen the protection, Anylon loop can be wound around the loop coil. Finally, use asphalt or soft resin to seal the slot.

